

QUICK START GUIDE



PA SERIES – MK3

PA 8 Ultra, PA 16

Full Range Power Amplifiers



STORM|AUDIO

VERSION 1.0

Last update: May 2022

IMPORTANT SAFETY INSTRUCTIONS



The book with exclamation mark symbol is intended to alert user that it is recommended to read this owner manual before installing and powering up the product.



The lightning flash with arrowhead symbol within an equilateral triangle, is intended to alert the user to the presence of uninsulated "dangerous voltage " within the product's enclosure that may be of sufficient magnitude to constitute a risk of electric shock to persons.

WARNING: TO REDUCE THE RISK OF FIRE OR ELECTRIC SHOCK, DO NOT EXPOSE THIS APPARATUS TO RAIN OR MOISTURE.



The exclamation point within an equilateral triangle is intended to alert the user to the presence of important operating and maintenance (servicing) instructions in the literature accompanying the product.



The wave symbol next to the voltage information (100V-240V 50/60Hz) is intended to alert the user that the unit should be powered by an alternating current (AC) source, so called mains power outlet, of the electrical installation.



The protective ground symbol (CEI 60417-5019 (2006-08)) identifies any terminal which is intended for connection to an external connector for protection against electric shock in case of a fault, or the terminal of a protective earth (ground) electrode.

1. Read these instructions.
2. Keep these instructions.
3. Heed all warnings.
4. Follow all instructions.
5. Do not use this apparatus near water.
6. Clean only with dry cloth.
7. Do not block any ventilation openings. Install in accordance with the manufacturer's instructions.
8. Do not install near any heat sources such as radiators, heat registers, stoves, or other apparatus (including amplifiers) that produce heat.
9. Do not defeat the safety purpose of the polarized or grounding-type plug. A polarized plug has two blades with one wider than the other. A grounding type plug has two blades and a third grounding prong. The wide blade or the third prong are provided for your safety. If the provided plug does not fit into your outlet, consult an electrician for replacement of the obsolete outlet.
10. Protect the power cord from being walked on or pinched particularly at plugs, convenience receptacles, and the point where they exit from the apparatus.
11. Only use attachments/accessories specified by the manufacturer.
12. Use only with the cart, stand, tripod, bracket, or table specified by the manufacturer, or sold with the apparatus. When a cart is used use caution when moving the cart/apparatus combination to avoid injury from tip-over.
13. The apparatus weight exceeds 13 kg, could drop and causes serious injuries. Move the apparatus with care.
14. Unplug this apparatus during lightning storms or when unused for long periods of time.
15. Refer all servicing to qualified service personnel. Servicing is required when the apparatus has been damaged in any way, such as power-supply cord or plug is damaged, liquid has been spilled or objects have fallen into the apparatus, the apparatus has been exposed to rain or moisture, does not operate normally, or has been dropped.
16. Do not open. No user serviceable parts inside. Refer servicing to qualified service personnel.
17. To completely disconnect this equipment from the AC mains, disconnect the power supply cord plug from the AC receptacle.
18. The mains plug of the power supply cord shall remain readily operable.
19. Do not expose this equipment to dripping or splashing and ensure that no objects filled with liquids, such as vases, are placed on the equipment.
20. For safety and electrical shock reasons, it is recommended to use this device in a non-tropical environment with temperature not exceeding 45°C and altitude not exceeding 2000m.



WARRANTY

Liability

The legal guarantees of conformity under no circumstances cover any damage arising from accidents, misuse or an assembly error, negligence or considerable modification of the appearance or functioning of the product. Immersive Audio Technologies reserves its right to refuse any return for a damaged product on account of misuse.

Terms of warranty

All StormAudio products are covered by warranty drawn up by the official StormAudio distributor in your country. Your distributor can provide all details concerning the conditions of warranty. Warranty cover extends at least to that granted by the legal warranty in force in the country where the original purchase invoice was issued. Warranty is valid only in the country the product was originally sold. StormAudio reserves the right to refuse the free application of the warranty if a copy of the invoice stating purchase date, model and serial number is not presented.

To prevent any damage or loss/deletion of data stored on the device, you must have saved them prior to returning your device to the services responsible hereunder, using the Backup Configuration feature available in the System page.

Transport cost to mainland France or other official technical center is at the expense of the customer. The device is transported at the risk of the customer. We strongly recommend to store the original packaging for any transportation. In the event of any damage observed upon its return, all the reservations must be made by the recipient with the carriers.

TECHNICAL SUPPORT

Check resources on our website

In case you need support, please consult our website to check our Download, Tutorial and Webinar sections. You will find manuals, explanatory videos and more resources that could help you:

<https://www.stormaudio.com/technical-support>

You can also check our interactive Knowledge Base Center:

<https://www.stormaudio.com/knowledge-base>

Ask your reseller

If you require technical support on your StormAudio products, or if you have any product related questions, please first contact your reseller.

Open a ticket on our Help Desk

If your reseller cannot solve your issue or if you don't find the info you need in our various support contents, please open a ticket on our Help desk:

<https://www.stormaudio.com/help-desk>

Provide as much information as possible about your product, your setup, the devices used as well as steps to reproduce the problem. Ideally, if possible, download the Configuration and Logs files from the System page and add them to the ticket.

BEFORE STARTING

Welcome

Thank you for choosing a StormAudio Multi Channel Power Amplifier. This guide provides step-by-step instructions to quickly set up your PA.

The PA range is based on a common Class D technology delivering high grade performance and sonical quality. All PAs share the same backbone, but models differ by the number of outputs. This guide will describe the connectivity of each model.

We continuously strive to improve our products. Some features might have thus been added or improved recently. Please check our website: <https://www.stormaudio.com> to get access to the Firmwares and documentation, and keep your PA up to date by upgrading it to the latest available firmware package.

What's in the box

Power Amplifier	
Quick Start Guide	Safety Instructions
Rack Mount ears *	Power Cord*

* tools are required to mount/unmount the rack mount ears: Torx screwdriver (T20).

* depending on the region, the power cord will be delivered with Fuse to be installed.

What you need

Immersive Sound Processor or Pre-amplifier	
XLR cables	Speakers with cables
LAN router with Cat5/6 RJ45 cable *	Optional: 3.5mm jack cables for triggers

* the PA needs a DHCP server to be part of the Network and get an IP address allocated. Make sure to check your Internet Provider Box or LAN/Switch box for router function.

Requirements

1. In case the AC cord is delivered with Fuses attached, make sure to install them before connecting the unit.
2. Ensure your electrical circuit has a good ground connection with all audio equipment connected to the same ground node to avoid a ground loop.
3. The PA get cooled down thanks to a regulated FAN control system. The PA pulls air from the bottom of the front plate, you should ensure a 1/2 RU space below it for air flow. In addition, the front and back panels should be free to maintain a correct air flow and cool down.

Installation Flow

Only a few steps are required to setup your PA for a basic setup, as summarized below:

- 1 Panels Overview
- 2 Connections | Power & Control
- 3 Connections | Normal mode
- 4 Connections | Bridged mode
- 5 Power Up
- 6 Web User Interface
- 7 Unit Status
- 8 Wiring Recommendations

Explore the next pages of this Quick Guide to go through each steps of the configuration of your PA.

SPECIFICATIONS

Channels configuration

PA 8 Ultra	8 channels max. - Normal mode 4 channels max - Bridged mode
PA 16	16 channels max - Normal mode 4 channels max - Bridged mode

Audio specifications

Frequency Response High -3dB CEM	50kHz
Frequency Response Low -3dB CEM	10 Hz
Signal / Noise Ratio (A-weighted) Referred to P-rated	> 115 dB
THD (20Hz-20kHz) 1 Watt to -1 dB max. power	< 0.03 %
Damping factor	> 400

Normal Mode - Output power

2 channels driven RMS 8 Ohms - 1kHz - 0.2% distortion	200 W max.
2 channels driven RMS 8 Ohms - 1kHz - 1% distortion	250W max.
All channels driven RMS 8 Ohms - 20Hz-20kHz 0.2% distortion	200W max.
Gain	26 dB

Bridged Tied Load - Output power

2 channels driven RMS 8 Ohms - 1kHz - 0.2% distortion	800W max.
2 channels driven RMS 8 Ohms - 1kHz - 1% distortion	1000W max.
All channels driven RMS 8 Ohms 20Hz-20kHz -0.2% distortion	800W max.
Gain	32 dB

Control

Network	100 Mbps Ethernet
Triggers	In & Out (2s delay)

Power Supply

Type	Switching Mode with universal range
Electrical characteristics	100V - 120V / 220V - 240V; 50/60Hz; 1000W
Fuses	100-120V: T10AL 250V ; 220V-240V: T5AL 250V

Weight and Dimensions

L x W x H (cm / inches) With box	49,1 x 44,2 x 15 67 x 63 x 30
PA8 Ultra Weight	16,6 KG 36,60 LBS
PA16 Weight	17,3 KG 38,14 LBS

Casing

Home/Rack removable ears	Yes
Rack Size	3 RU

Our policy of continual product improvement means that StormAudio reserves the right to modify the technical specifications of its products without notice. Product may vary from images.

1 - PANELS OVERVIEW

PA 8 Ultra

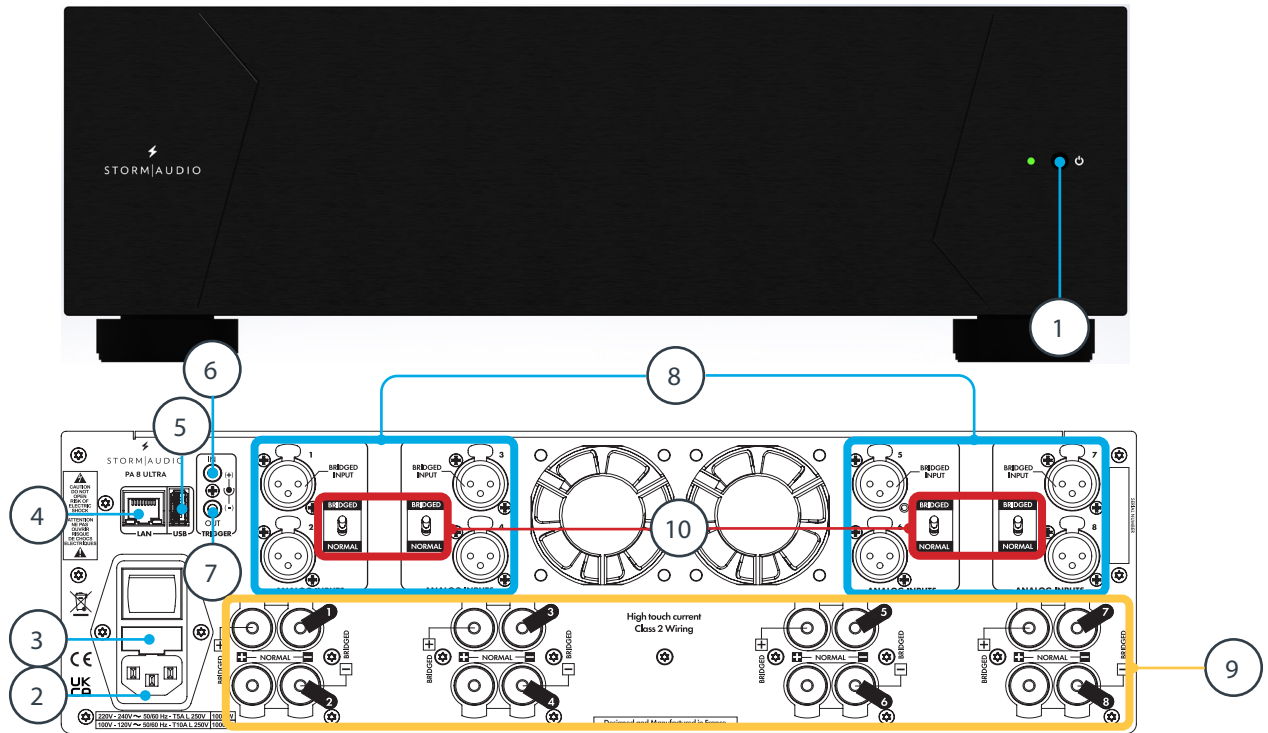

- | | | | |
|---------------------|------------------|-------------------------------------------|--------------------------------------|
| 1. Standby button | 4. Ethernet port | 7. Trigger output | 9. Channels 1 to 8 outputs |
| 2. AC Inlet | 5. USB port | 8. Channels 1 to 8
Balanced XLR inputs | 10. Bridged/Normal mode
selectors |
| 3. Fuse compartment | 6. Trigger input | | |

PA 16

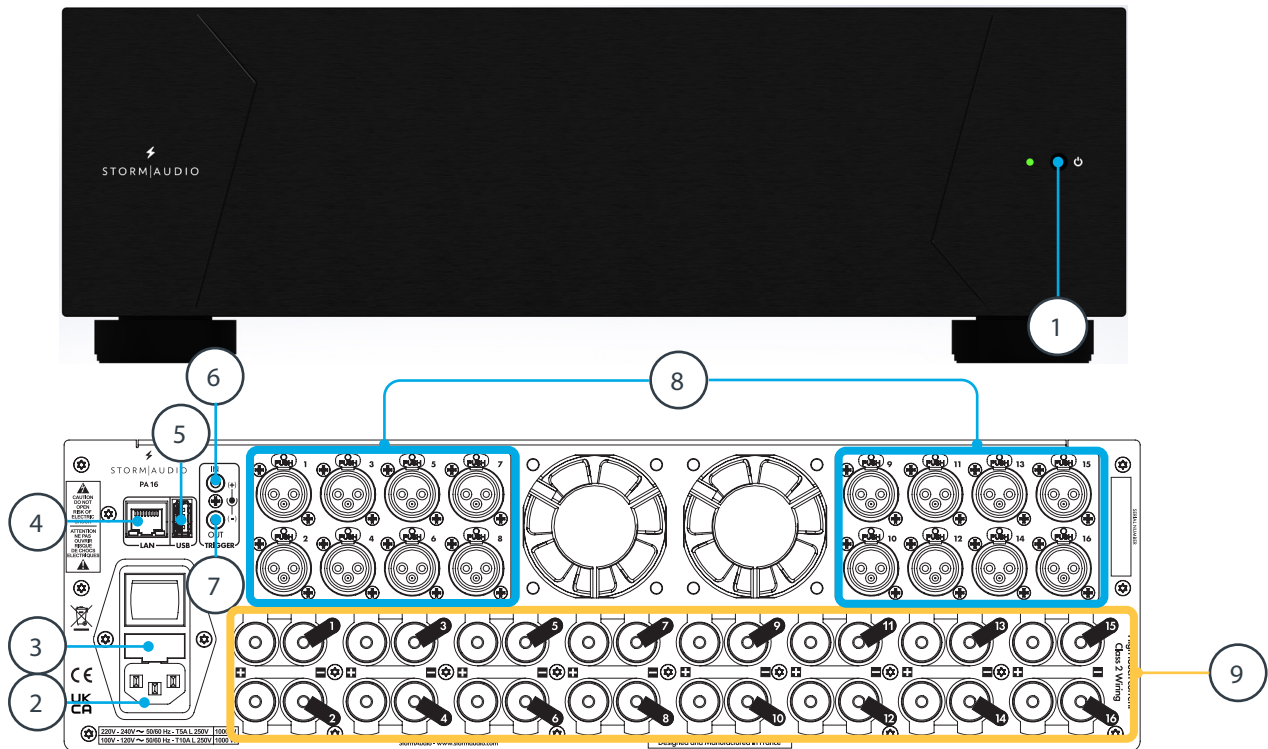

- | | | | |
|---------------------|------------------|--------------------------------------------|--------------------------------|
| 1. Standby button | 4. Ethernet port | 7. Trigger output | 9. Channels 1 to 16
outputs |
| 2. AC Inlet | 5. USB port | 8. Channels 1 to 16
Balanced XLR inputs | |
| 3. Fuse compartment | 6. Trigger input | | |

2 - CONNECTIONS | POWER & CONTROL

PA 8 Ultra

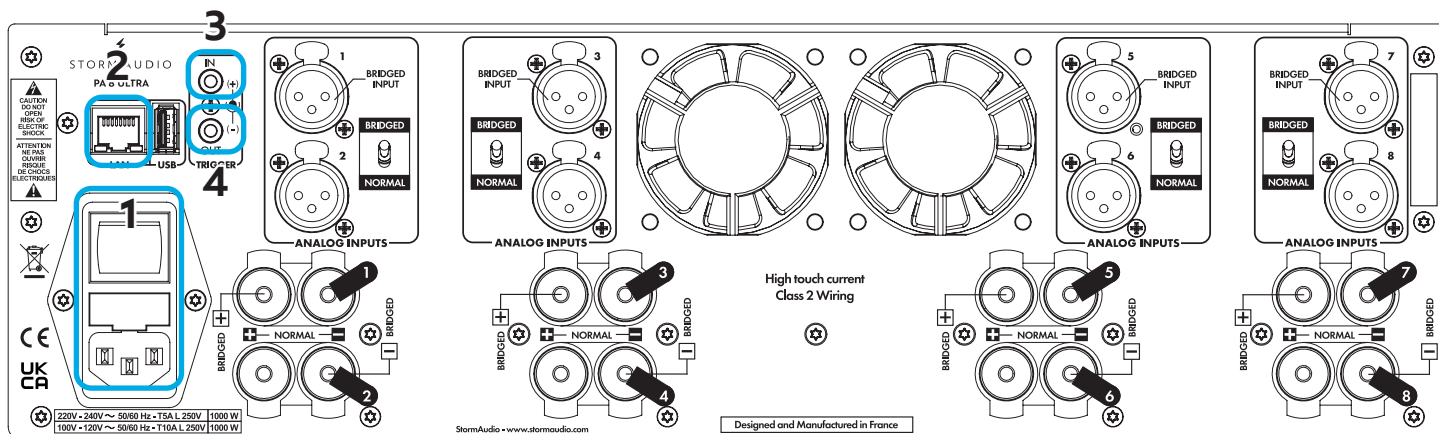

PA 16

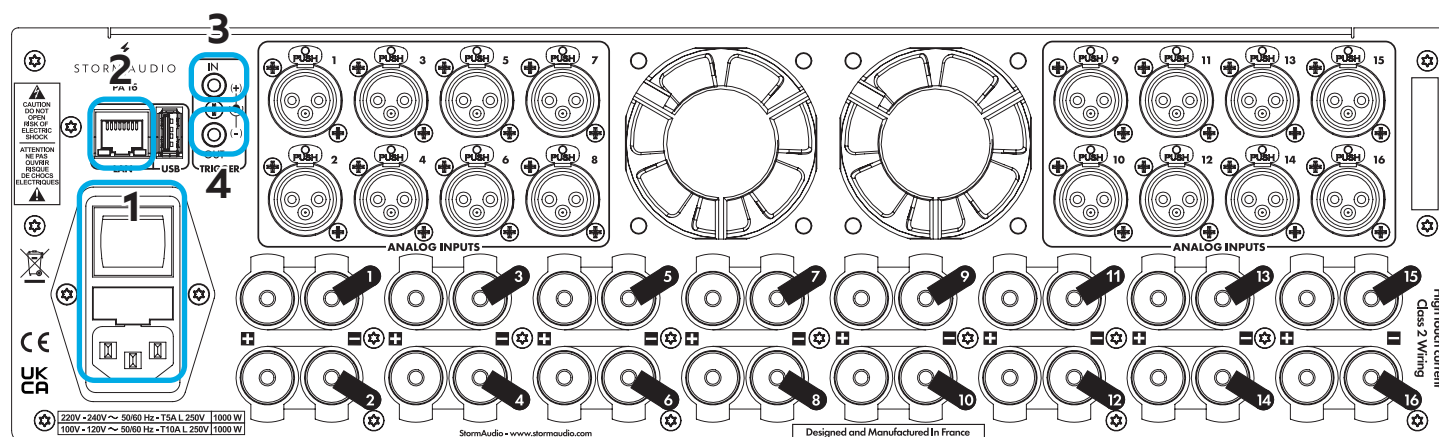

1. Connect your AC cable to a grounded outlet and to the amplifier power socket. If the AC is delivered with Fuses attached, make sure to install them before connecting the unit.
2. Connect your RJ45 LAN cable to your router and to the amplifier LAN port.
3. **Optional:** The PA can be controlled remotely by the StormAudio ISP or an external controller via its Trigger Input. You must setup your controller Trigger output to 12V Active Status. The PA will react to a rising edge to power up. Connect the trigger output of your sound processor to the trigger Input of the amplifier to initiate the connection.
4. **Optional:** If you need to control several amplifiers or devices, you can daisy chain the Trigger control by connecting the trigger output of the amplifier to another amplifier or device. The input and output triggers are internally delayed by 2s.

Note:

The Trigger interfaces use a standard 3.5mm mono jack connector.
A wire as shown herewith is recommended.



3 - CONNECTIONS | NORMAL MODE

PA 8 Ultra

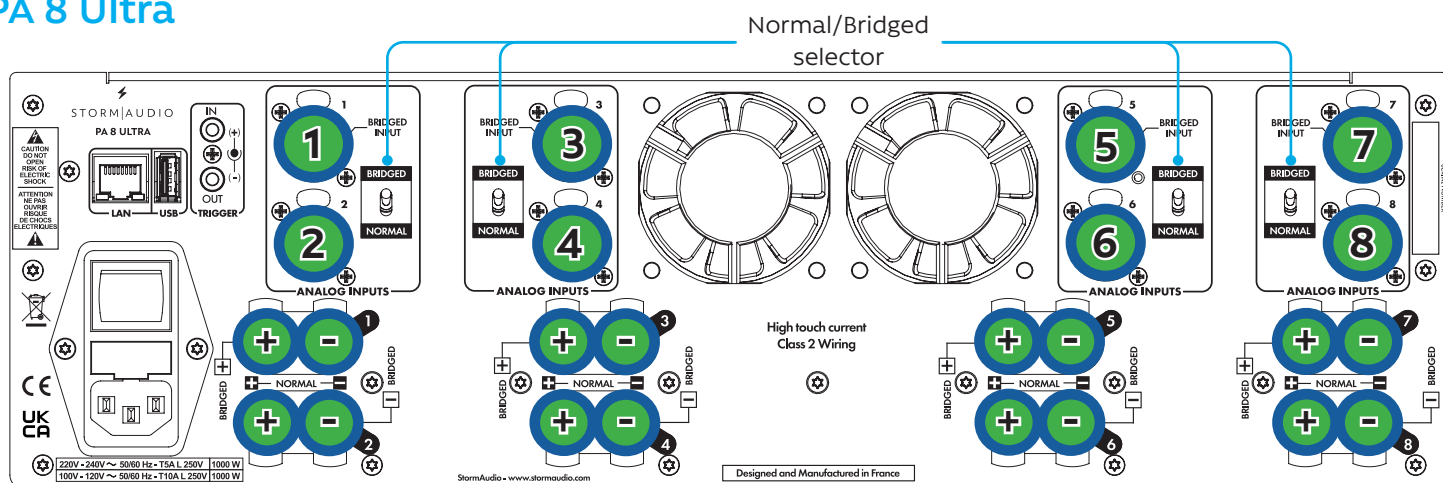

1. Set the amplifier input pairs to «Normal» using the switch selector.
2. Connect your preamplified balanced XLR channels to the amplifier XLR inputs.
3. Connect your speakers (4 to 16 Ohms) to the amplifier outputs. Our binding posts support «banana plugs» and wires up to 4.5mm².

PA 16

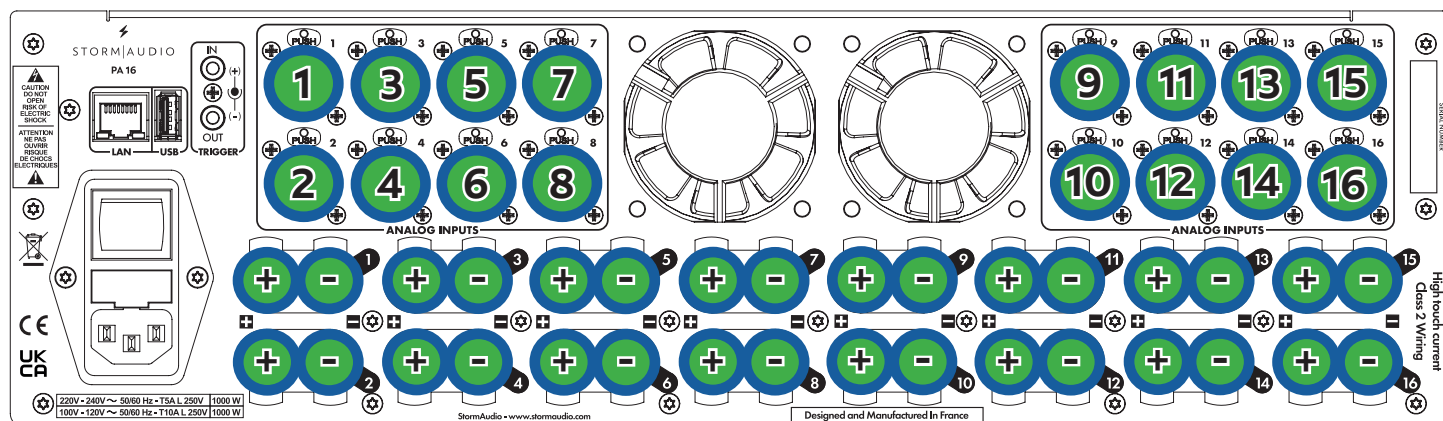

1. Connect your preamplified balanced XLR channels to the amplifier XLR inputs.
2. Connect your speakers (4 to 16 Ohms) to the amplifier outputs. Our binding posts support «banana plugs» and wires up to 4.5mm².

Speakers connection optimization

The PA 8 and PA 16 are made of Master & Slaves modules, with the power supplies located in the Master Modules. The amplifier lines on master modules are thus a bit more powerful, in consequence, we recommend connecting demanding speakers such as LF, CF, RF and Subwoofers to these channels:

Model	PA 8 Ultra	PA 16
Channels	1 3 5 7	1-2 5-6 9-10 13-14

Note:

These inputs are also the «bridgeable» inputs, allowing for more power into your speakers.
See next how to set them up.

4 - CONNECTIONS | BRIDGED MODE

Bridged mode

Some pairs of channels in the PAs can be set in «Bridged» mode, offering up to 800W maximum power, instead of the 200W max power in Normal mode. This is possible at the cost of using a pair of outputs instead of a single output to get the necessary power. See below how to set your PA and connections for Bridged mode.

PA 8 Ultra

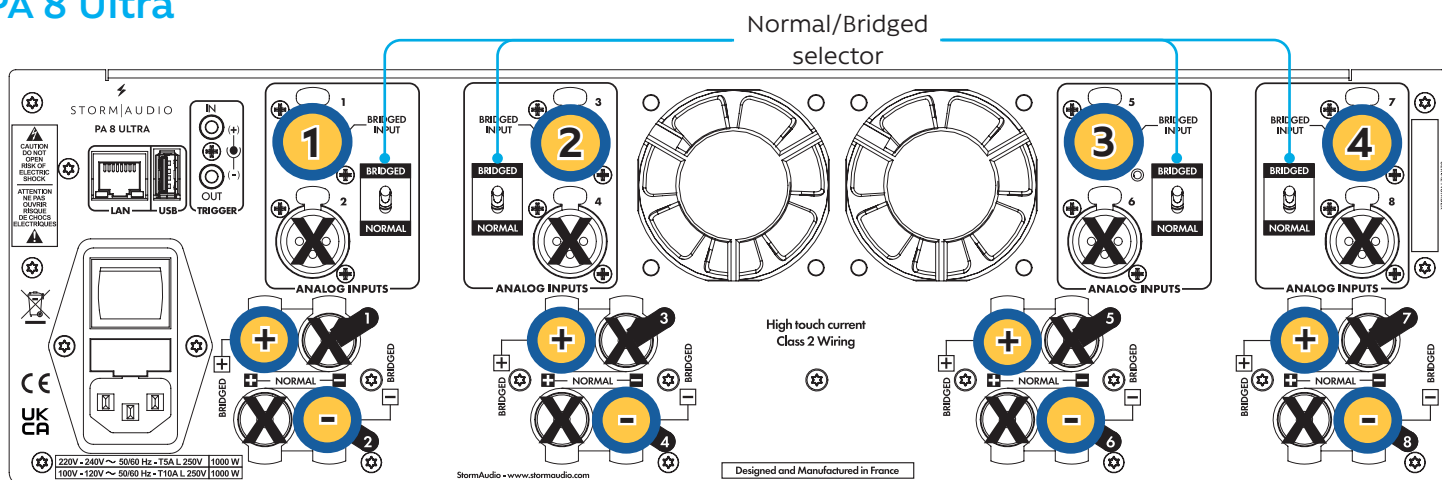

1. Set the amplifier input pairs to «Bridged» using the switch selector.
2. Connect your preamplified balanced XLR channels to the amplifier XLR inputs 1, 3, 5 and/or 7. Do not use the 2, 4, 6 and/or 8 inputs in bridged mode.
3. Connect your speakers (4 to 16 Ohms) to the amplifier outputs, following the above schematic. Our binding posts support «banana plugs» and wires up to 4.5mm².

PA 16

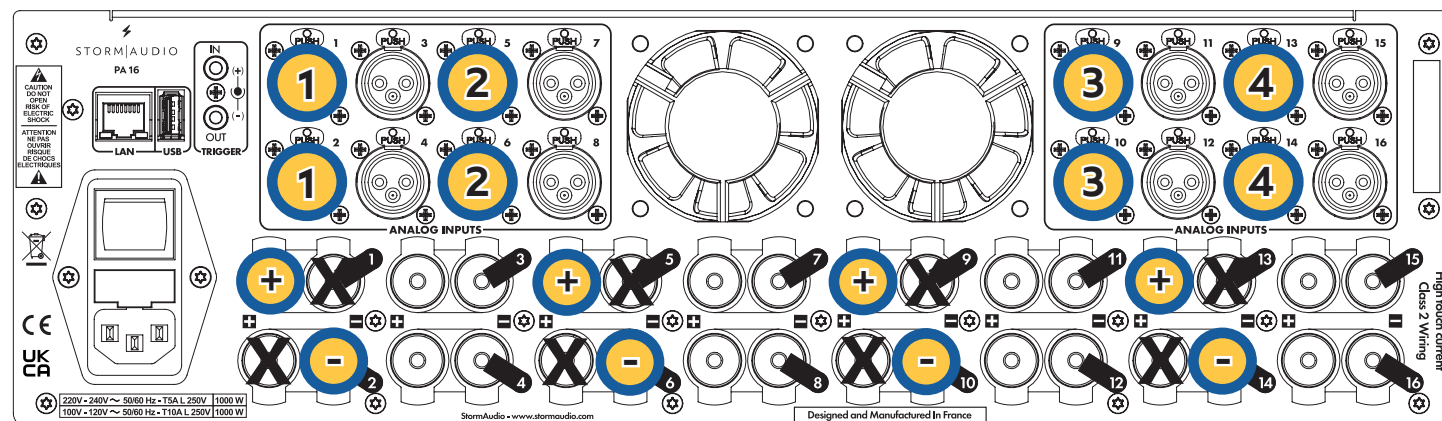

1. Use an «Y» XLR cable to make the bridged connection input as shown above. You can purchase such cables from us. Contact orders@stormaudio.com.
2. You can use the 3, 4, 7, 8, 11, 12, 15, 16 inputs concurrently with the bridged inputs. Make sure to have sufficient air flow around your PA when using bridged mode to dissipate the heat.
3. Connect your speakers (4 to 16 Ohms) to the amplifier outputs, according to the above schematic. Our binding posts support «banana plugs» and wires up to 4.5mm².

Note:

As long as you follow the above schematics, you can mix single and bridged mode channels as you see fit.

5 - POWER UP

Power up sequence

1. Turn the main switch to ON (I) on the back panel.
2. The front panel LED will blink for a few seconds and will remain red, indicating Sleep Mode.
3. When in Sleep Mode, press the Power Button on the front panel or activate the Trigger in your controller. The front panel LED will start blinking red for a few seconds before turning to a steady green, indicating Normal Mode.

6 - WEB USER INTERFACE

First time access

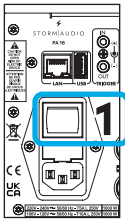

1. Turn the Main Switch to ON (I) on the back panel.
2. When in Sleep Mode, press the Power Button. Unit will start. Wait until the LED is stable green.
3. Find the IP address of your PA using an IP finder. There are many available for free on the internet.

Note: You can also use a StormAudio ISP and go to its WebUI Monitoring page:

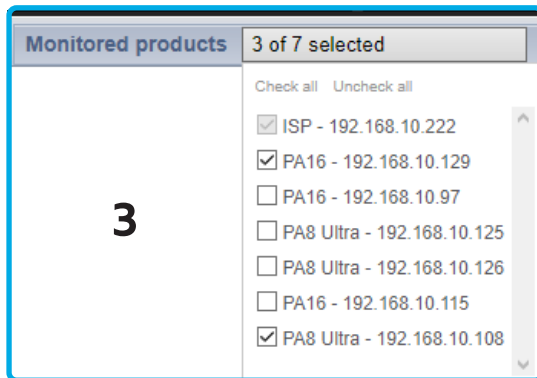

1. On the upper left, you can find «Monitored products» and a dropdown list. The ISP will gather all of the StormAudio products available on the network. You can select which to Monitor in the WebUI of the ISP, and they will appear below. You will find temperatures of the PA, fan speeds and event logs. You can also select to power on/off and mute on/off the PAs from here. The IP address will be shown and you can also click on it to access its WebUI.
2. Once in the WebUI of the PA, enter the installer password to proceed.

Web User Interface description

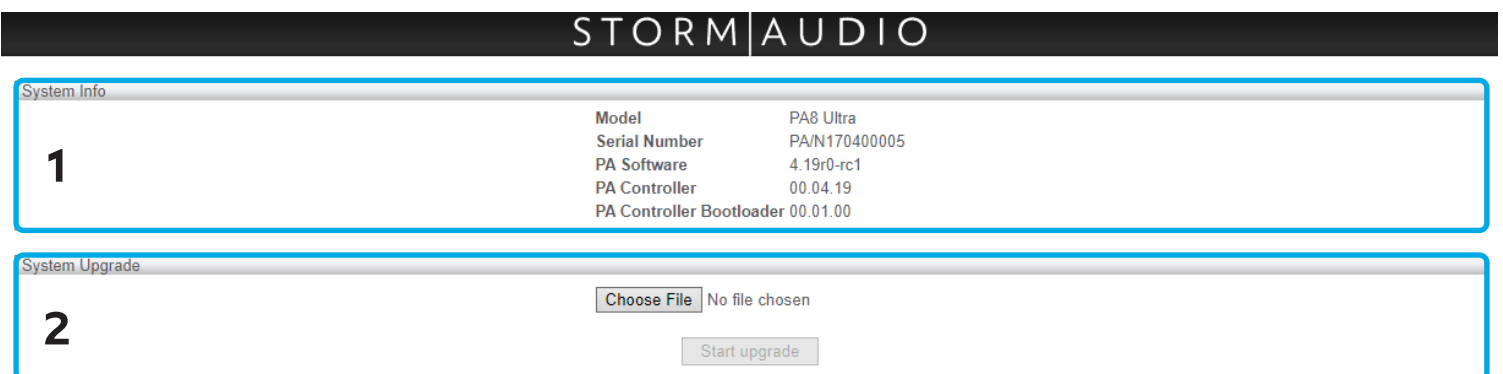

1. **System Info.** Will display the general information about your PA. Model, Serial Number, Firmwares versions.
2. **System Upgrade.** A simple way to update your unit to the latest version. Select the firmware file on your computer then click on «Start Upgrade». The firmware files can be found in our Client Portal.

The update can also be done from an ISP's WebUI. On the system page, you will find a button named «PA Firmware Upgrade» if a PA is on the same network as the ISP. The process to update your PA is the same as mentioned above. Simply select a file and click «Start Upgrade».





Note:

The upgrade process can take a few minutes to complete. Do not power off your unit during this time.

7 - UNIT STATUS | LED

Unit Status

The unit front panel LED indicates the current Status of the PA. See the table below:





Unit Status	Description	LED status
Sleep Mode	In this mode the unit is turned off. It can be activated via the Triggers or the Network.	 Static RED
Initializing	From the Sleep Mode to the Normal Mode and Vice Versa, the unit has to be initialized and properly turned off. This only lasts for a few seconds with no sound.	 Blinking RED
Upgrade in progress	The PA firmware can be upgraded over the Network. When this occurs, the unit falls in a specific mode with no other activity possible. Do not power off the unit during the upgrade.	 Blinking GREEN
Normal Mode	The PA is in its normal playback mode with no failure detected.	 Static GREEN

Power Amplifier Protections

The PA range includes a set of protection mechanisms to ensure its best reliability. The system will react to the following events:

- **Fan Failure:** An active cooling regulation is integrated, powered by no less than 6 low noise high speed capable fans. Although extremely reliable over the product life time, we continuously monitor the fans to ensure stability.
- **Overheat:** In very extreme conditions, such as high power demand in a extreme high temperature environment, the heat dissipation can reach temperatures that can harm the unit if not managed properly.
- **Overcurrent:** To prevent shortage at the output that can damage the amplifier stages, the output current is monitored continuously.
- **Overvoltage:** Amplifier stages can be damaged in a few occasions. Overvoltage at the power supply level is one of them. To prevent failure to occur in such event, we monitor the power supplies of the amplifier rails.

The unit front panel LED indicates the Protection States of the PA. See the table below:

Protection activated	Description	LED status
Unit Overheat	An ambient temperature sensor measures the internal temperature. If above 60°C, the unit will go to Sleep Mode. In case the PA is Trigger controlled, the unit will restart when the temperature falls under 55°C.	 2Hz blinking YELLOW
Overcurrent Overvoltage Module Malfunction	The unit will MUTE the channels that are showing the problem. This will be released automatically.	 1Hz blinking YELLOW
Module Overheat	Each amplifier module is monitored for temperature. The unit will MUTE the channels automatically when threshold is reached. This will be released automatically.	 2Hz blinking YELLOW
FAN Failure	A FAN failure will not prevent the unit from working correctly. Overheat protection might nevertheless be triggered more easily.	 Static YELLOW

8 - WIRING RECOMMENDATIONS

Special care must be taken of for the cables, wires and connectors to be used with the PA. Here is a description of the connectors pinout and recommendation for the wiring.

XLR pin out

To connect your PA to an ISP, you must use male to female XLR cables. The connector in the PA is a Female XLR. The connector in the ISP is a Male XLR. We recommend cables up to 3m to link your processor to the PA.

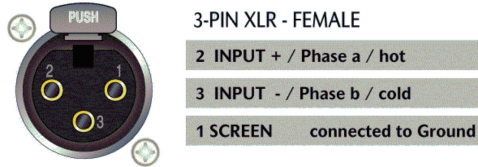

RCA to XLR unbalancing cable

It is required to connect to the amplifiers with balanced input.

In case your processor outputs are unbalanced, the wiring should be done as shown below:



USB port

There is an USB port available used for USB upgrade when no network access is available. The port can be used to provide 5V power supply in the limit of 500mA maximum consumption.

REGULATIONS

FCC and IC compliance notice

This device complies with part 15 of the FCC Rules. Operation is subject to the following two conditions: (1) This device may not cause harmful interference, and (2) this device must accept any interference received, including interference that may cause undesired operation.

This Class B digital apparatus complies with Canadian ICES-003.

Cet appareil numérique de la classe B est conforme à la norme NMB-003 du Canada.

CAUTION: Changes or modifications not expressly approved by the party responsible for compliance could void the user's authority to operate the equipment.

NOTE: This equipment has been tested and found to comply with the limits for a Class B digital device, pursuant to Part 15 of the FCC Rules. These limits are designed to provide reasonable protection against harmful interference in a residential installation. This equipment generates, uses and can radiate radio frequency energy and, if not installed and used in accordance with the instructions, may cause harmful interference to radio communications. However, there is no guarantee that interference will not occur in a particular installation. If this equipment does cause harmful interference to radio or television reception, which can be determined by turning the equipment off and on, the user is encouraged to try to correct the interference by one or more of the following measures:

- Reorient or relocate the receiving antenna.
- Increase the separation between the equipment and receiver.
- Connect the equipment into an outlet on a circuit different from that to which the receiver is connected.
- Consult the dealer or an experienced radio/TV technician for help.

CE declaration

Immersive Audio Technologies hereby declares that this equipment is in compliance with the EMC 2014/30/UE Directive, LVD 2014/35/UE Directive, ErP 2009/125/CE Directive and RoHS 2011/65/CE Directive.



WEEE Notice

The Directive on Waste Electrical and Electronic Equipment (WEEE, DEEE 2012/19/UE) resulted in a major change in the treatment of electrical equipment at end-of-life.

The purpose of this Directive is, as a first priority, the prevention of WEEE, and in addition, to promote the reuse, recycling and other forms of recovery of such wastes so as to reduce disposal.

The WEEE logo on the product or on its box indicating collection for electrical and electronic equipment consists of the crossed-out wheeled bin, as shown here.



This product must not be disposed of or dumped with your other household waste. You are liable to dispose of all your electronic or electrical waste equipment by relocating over to the specified collection point for recycling of such hazardous waste. Isolated collection and proper recovery of your electronic and electrical waste equipment at the time of disposal will allow us to help conserving natural resources. Moreover, proper recycling of the electronic and electrical waste equipment will ensure safety of human health and environment. For more information about electronic and electrical waste equipment disposal, recovery, and collection points, please contact your local city center, household waste disposal service, shop from where you purchased the equipment, or manufacturer of the equipment.

RoHS Compliance

This product is in compliance with Directive 2011/65/EU of the European Parliament on the restriction of the use of certain hazardous substances in electrical and electronic equipment.

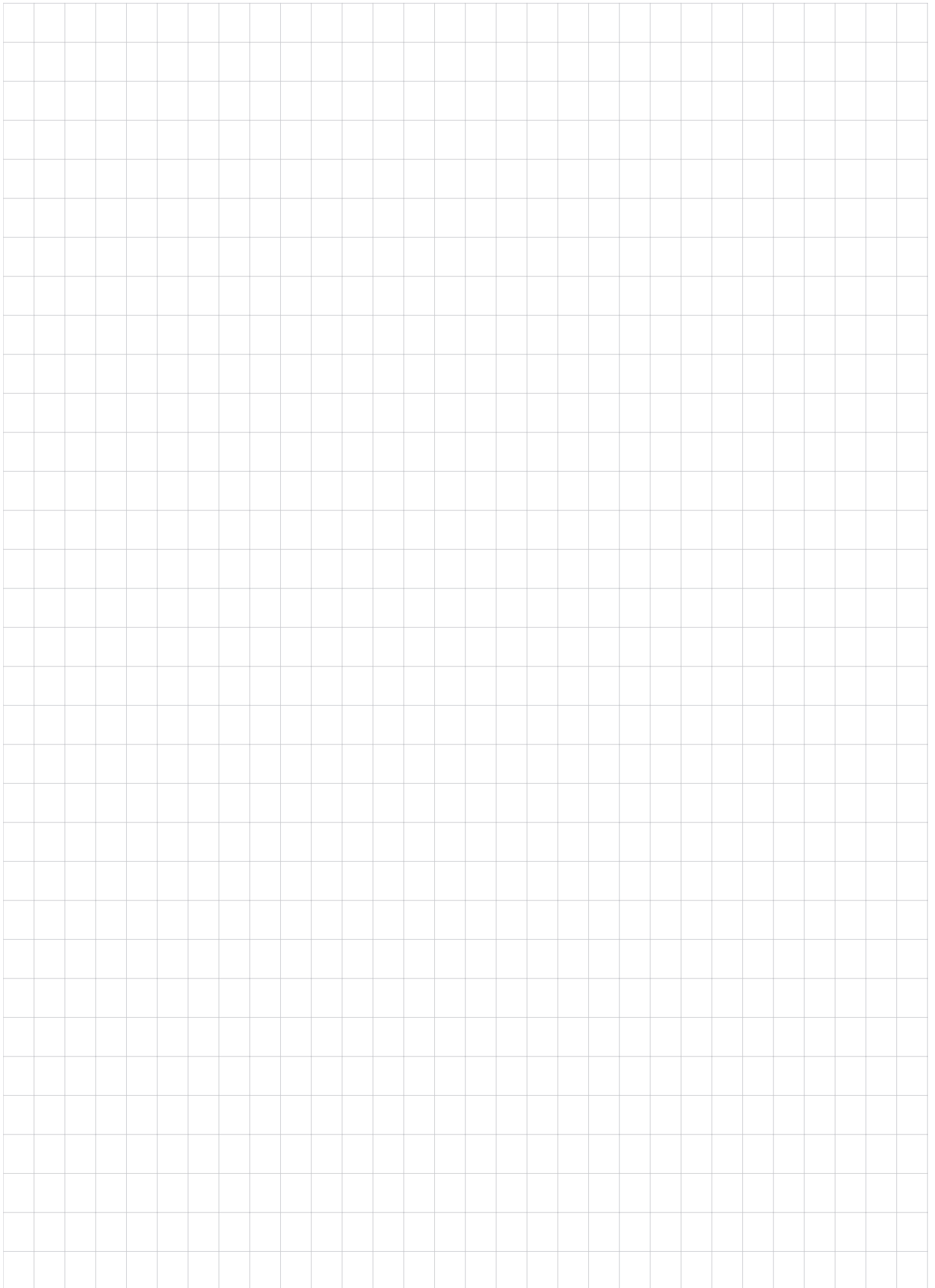



STORM|AUDIO

StormAudio | Immersive Audio Technologies
8 rue de la Rabotière | 44800 Saint-Herblain | France

